



MOUNTING HOLE

NOTE:MADE OF EQUIVALENT MATERIAL.

TOBY ELECTRONICS LTD
sales@toby.co.uk | toby.co.uk

 VALCON <small>QUALITY VALUE COMPONENTS</small>	DATE	2014.05.13	TITLE	LIGHT PIPE	DWG. NO.	LEM-180		PART NO.	LEM-180
	DRAWN	LUKE	MATERIAL	PC	SIZE	SPEC. DWG.		REV	B
	CHECKED		COLOR	TRANSPARENT	FINISH	SCALE: 3:1	UNIT	mm	SHEET 1 OF 1
	APPROVED		UNLESS OTHERWISE SPECIFIED TOLERANCE: SEE ABOVE						

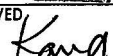
DO NOT SCALE DRAWING

MATTE FINISH

POLISHING FINISH

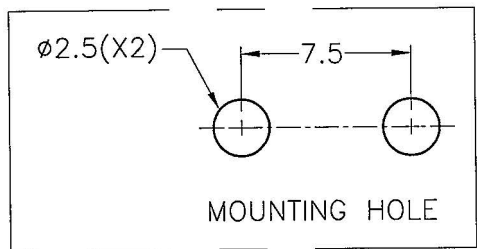
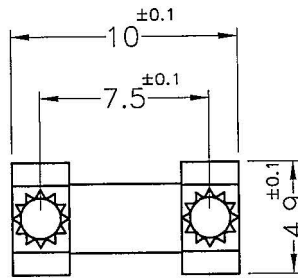
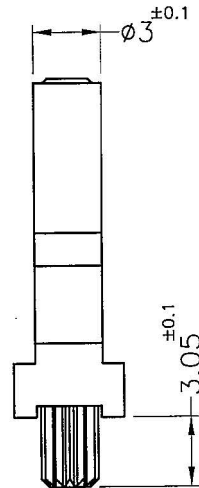
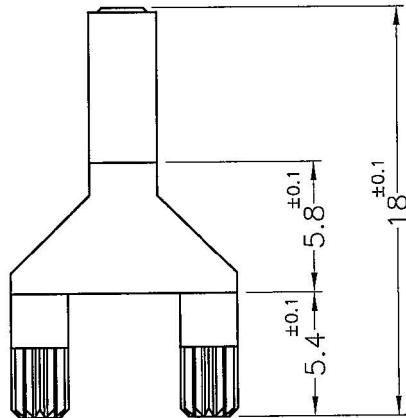
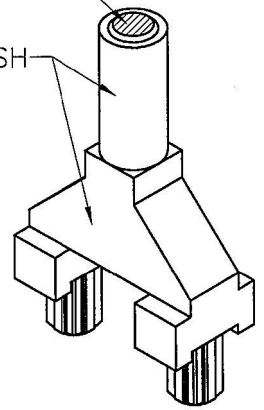

NOTE: MADE OF EQUIVALENT MATERIAL.

TOBY ELECTRONICS LTD
sales@toby.co.uk | toby.co.uk

	DATE	2021.04.27	TITLE	LIGHT PIPE	DWG. NO.	PART NO.	
	DRAWN	Howl	MATERIAL	PC UL94V-2	LEM-270	LEM-270	
	CHECKED	李柏宥	COLOR	TRANSPARENT	FINISH	SIZE	REV
	APPROVED	Kang	UNLESS OTHERWISE SPECIFIED TOLERANCE: SEE ABOVE		A4	SPEC. DWG	A
DO NOT SCALE DRAWING					SCALE: 3:1	UNIT mm	SHEET 1 OF 1