

DO NOT SCALE FROM THIS PRINT

NOTES:

1. SET UP AS ASP FOR VITA74.
2. Ⓢ REPRESENTS A CRITICAL DIMENSION.
3. MINIMUM PUSHOUT FORCE: 0.50 LBS
4. DIMENSION MUST BE MEASURED USING INSPECTION FIXTURE AT-1817-836-1. USE CO-AU-WI-2003-M FOR PROCESS.
5. SOLDER CHARGE VOLUME IS 0.891 x 10^-5 IN ^3 REF.
6. MAXIMUM ROW TO ROW VARIATION .003[0.08], MEASURED FIRST & LAST POSITIONS ONLY, ALL ROWS.
7. PARTS TO BE PACKAGED IN TAPE & REEL.  
ATTACH LABEL "SEAX-0001" TO EACH TAPE & REEL PACKAGE.

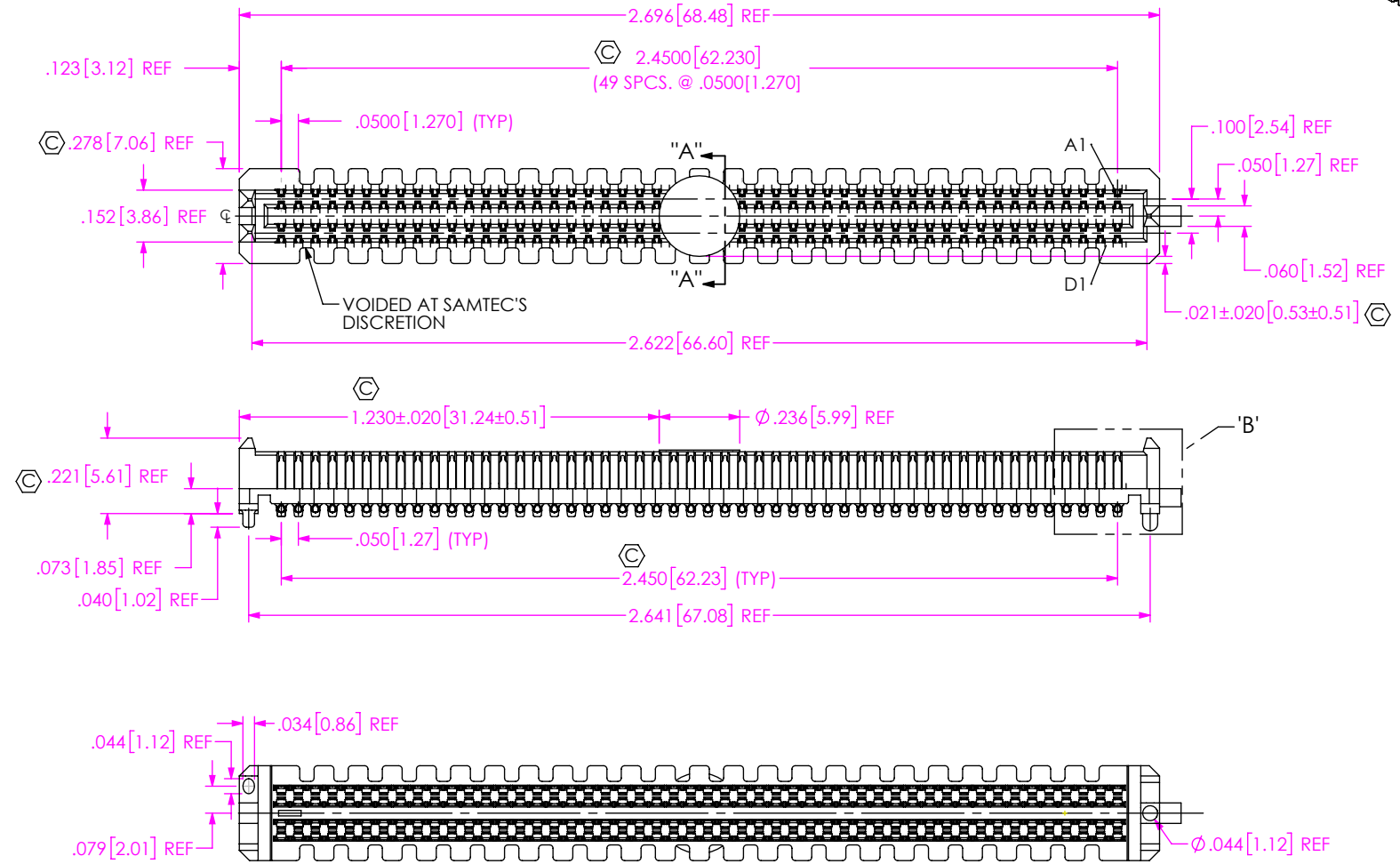
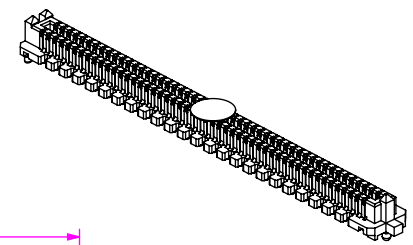

ITEM NO.	PART NUMBER	QUANTITY	MATERIAL
1	SEAM-50-02.0-04-A	1.0000	VECTRA E130i, COLOR: BLACK
2	NEW-SUB-T-1M36-02.0-S-2	200.00	COPPER ALLOY/LEAD FREE SOLDER
3	K-DOT-.236-.343-.005	1.0000	POLYIMIDE FILM
4	CT-SEAM044MS	.00286	CONDUCTIVE POLYMER

UNLESS OTHERWISE SPECIFIED, DIMENSIONS ARE IN INCHES.

TOLERANCES ARE:

DECIMALS	ANGLES
.XX: ±.01 [0.3]	2°
.XXX: ±.005 [0.13]	
.XXXX: ±.0020 [0.051]	

PROPRIETARY NOTE

THIS DOCUMENT CONTAINS CONFIDENTIAL AND PROPRIETARY INFORMATION AND ALL DESIGN, MANUFACTURING, REPRODUCTION, USE, PATENT RIGHTS AND SALES RIGHTS ARE EXPRESSLY RESERVED BY SAMTEC, INC. THIS DOCUMENT SHALL NOT BE DISCLOSED, IN WHOLE OR PART, TO ANY UNAUTHORIZED PERSON OR ENTITY NOR REPRODUCED, TRANSFERRED OR INCORPORATED IN ANY OTHER PROJECT IN ANY MANNER WITHOUT THE EXPRESS WRITTEN CONSENT OF SAMTEC, INC.

DO NOT SCALE DRAWING SHEET SCALE: 2:1

PLATING:  
CONTACT AREA: .000030 GOLD OVER .000050 NICKEL  
REMAINDER: .000200 REF TIN OVER .000050 NICKEL  
SOLDER COMPOSITION: 95.5% TIN/3.8% SILVER/0.7% COPPER Ⓢ

520 PARK EAST BLVD, NEW ALBANY, IN 47150  
PHONE: 812-944-6733 FAX: 812-948-5047  
e-Mail: info@SAMTEC.com code 53322

**samtec**

DESCRIPTION:  
MODIFIED .050 PITCH TERMINAL ARRAY ASM

DWG. NO. ASP-161073-03

BY: JACK Z 05/10/2021 SHEET 1 OF 2

F:\DWG\MISC\MKTG\ASP-161073-03-MKT.SLDDRW

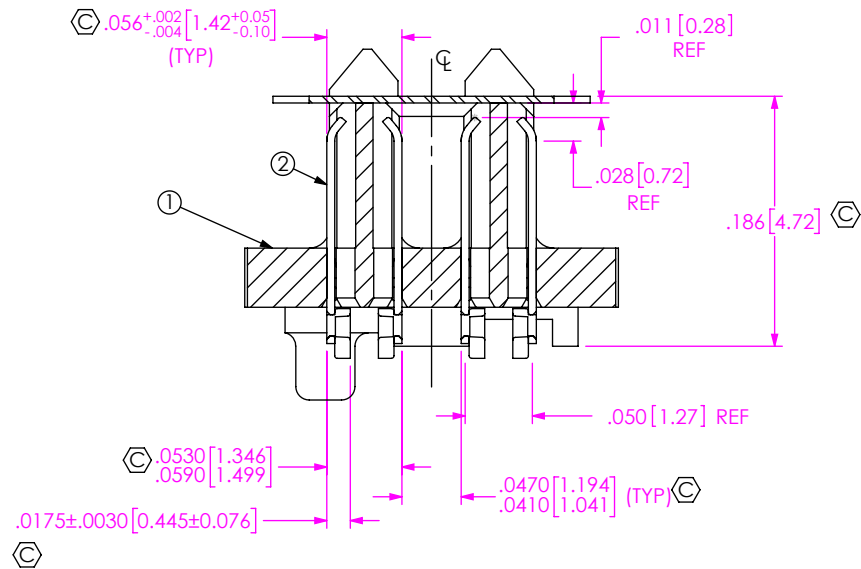

SECTION "A"-"A"  
SCALE 4 : 1

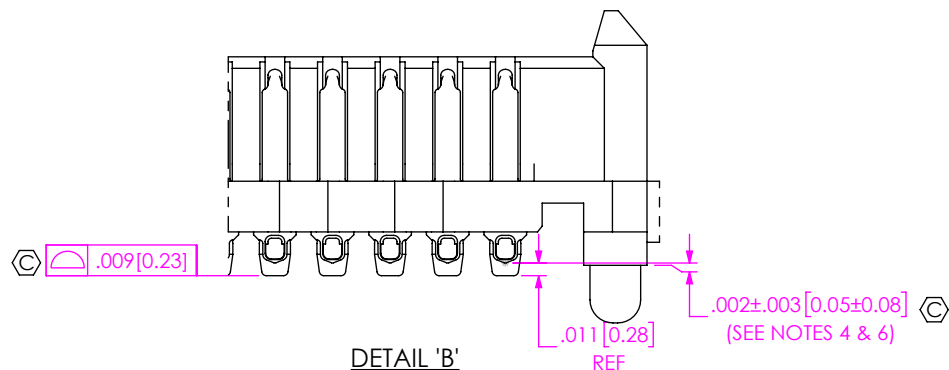

DETAIL 'B'  
SCALE 7 : 1

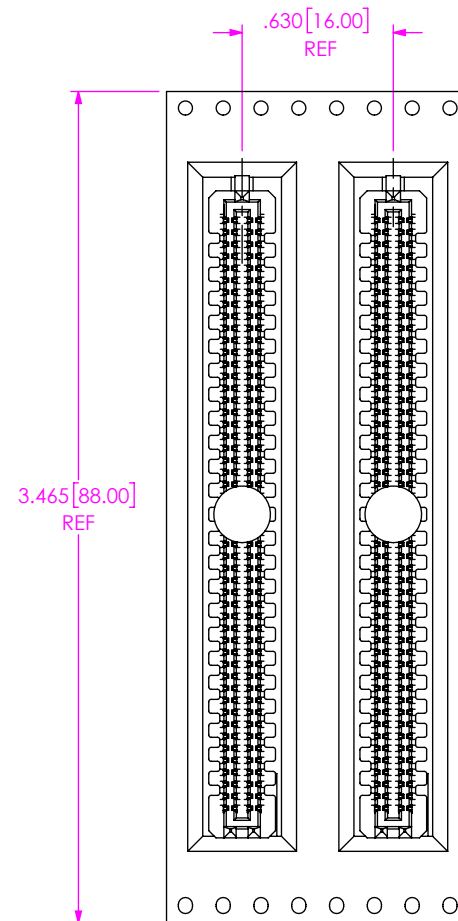

USER DIRECTION OF UN-REELING  
POCKET NOT DETAILED →

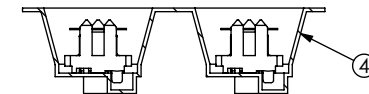

PACKAGING VIEW

PROPRIETARY NOTE

THIS DOCUMENT CONTAINS CONFIDENTIAL AND PROPRIETARY INFORMATION AND ALL DESIGN, MANUFACTURING, REPRODUCTION, USE, PATENT RIGHTS AND SALES RIGHTS ARE EXPRESSLY RESERVED BY SAMTEC, INC. THIS DOCUMENT SHALL NOT BE DISCLOSED, IN WHOLE OR PART, TO ANY UNAUTHORIZED PERSON OR ENTITY NOR REPRODUCED, TRANSFERRED OR INCORPORATED IN ANY OTHER PROJECT IN ANY MANNER WITHOUT THE EXPRESS WRITTEN CONSENT OF SAMTEC, INC.



520 PARK EAST BLVD., NEW ALBANY, IN 47150  
PHONE: 812-944-6733 FAX: 812-948-5047  
e-Mail: info@SAMTEC.com code 5332

SHEET SCALE: 2:1

DESCRIPTION:  
MODIFIED .050 PITCH TERMINAL ARRAY ASM

DWG. NO.  
ASP-161073-03



# SOSA ALIGNED INTERCONNECT SOLUTIONS

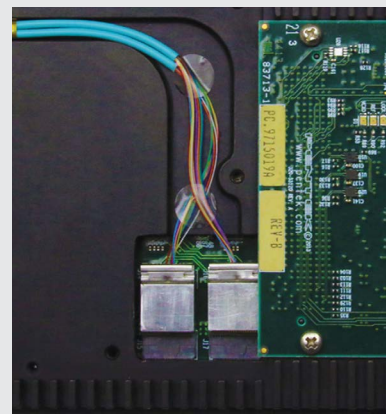
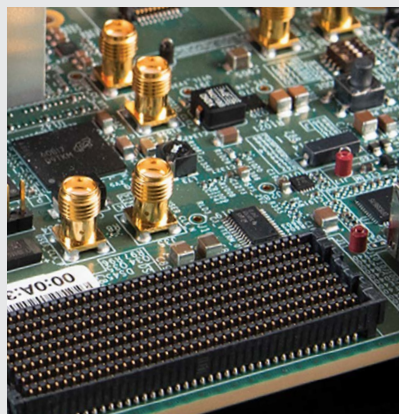
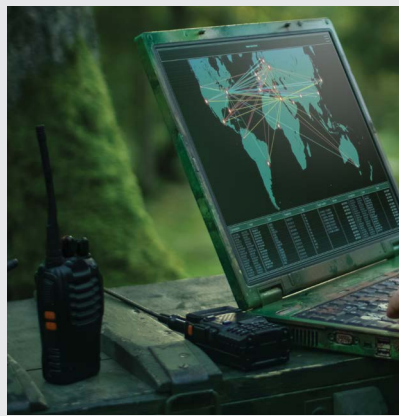
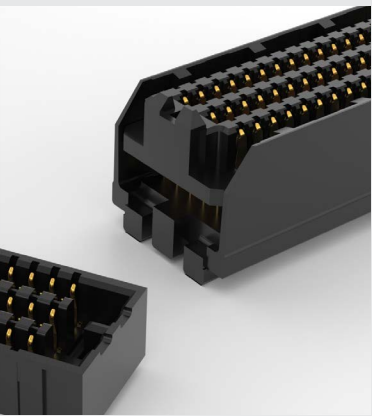

HIGH-PERFORMANCE SOLUTIONS FOR SENSOR OPEN SYSTEMS ARCHITECTURE



# INTERCONNECT SOLUTIONS

## FOR SENSOR OPEN SYSTEMS ARCHITECTURE (SOSA)

SOSA defines an architecture and standards to support all Department of Defense (DoD) branches by creating interoperable sensor modules. Samtec is an active member of the SOSA Consortium, delivering **Sudden Service® solutions** that help **enable rapid, affordable, cross-platform connectivity for military/defense applications.**

The SOSA Standard defines a set of logical modules that group functions, behaviors, and interfaces, which together define the logical architecture of a sensor. Many of these modules are connected using **Samtec high-performance interconnects, which provide the flexibility, modularity, size, weight and power demands of current and future SOSA-based technologies.**



### BENEFITS OF THE SOSA STANDARD

Reduce Development Cycle Time and Cost

Reduce Systems Integration Cost and Risk

Increase Commonality and Reuse

Enable Technology Transition

Facilitate Interoperability

Isolate the Effects of Change

Reduce Sustainment Modernization Cost

Support Capability Evolution

Mitigate Obsolescence

### INDUSTRY APPLICATIONS

Communications (Comms)

Electro-Optical/Infra-Red (EO/IR)

Electronic Warfare (EW)

Radar

Signals Intelligence (SIGINT) Systems

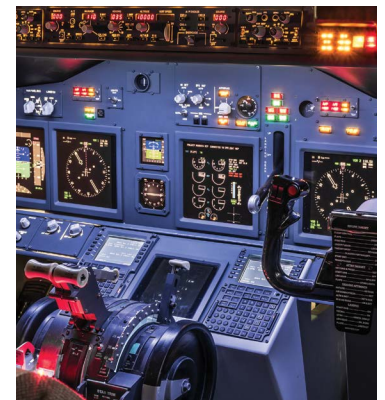

## TABLE OF CONTENTS

4-5

### SOSA Plug-In Cards (PICs) Using VNX

VITA 74 VNX SEARAY™  
The Expanding VNX™ Ecosystem

6-7

### SOSA Plug-In Cards (PICs) Using OpenVPX

VITA 42 XMC & VITA 88 XMC+ Connectors  
VITA 42, VITA 57.1/57.4 Precision Board Stacking Standoff  
VITA 57.1 FMC & 57.4 FMC+ Connectors  
VITA Optics



## PRODUCT SOLUTIONS

Small Form Factor (SFF) • Rugged Designs • High-Speed • High-Reliability • High-Density

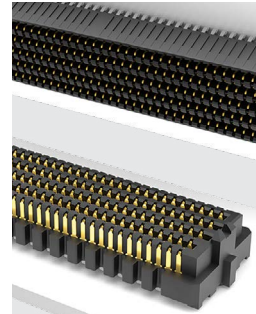
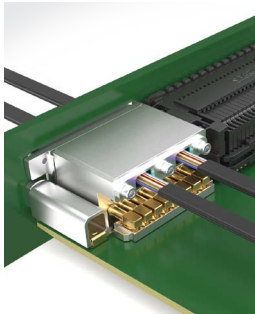

### SMALL FORM FACTOR (SFF) DESIGNS

Samtec is a leader in ruggedized Small Form Factor (SFF) solutions, with modular systems designed to incorporate flexible mixed signaling requirements.

Our focus on SFF designs also means we are mindful of the Size, Weight and Power (SWaP) impact.

### HARDWARE PLUG-IN CARD (PICs) STANDARDS

VITA 42 XMC specifies Samtec's SamArray® connectors, which provide mezzanine expansion and customization capabilities for SOSA™ PICs using OpenVPX™.

VITA 74 VNX provides high-speed capabilities, rugged design and small form factors for SOSA PICs using VNX.

### SEVERE ENVIRONMENT TESTING

SET-qualified products have been tested beyond typical industry standards for performance confidence in rugged military, aerospace and defense applications. For additional details, please visit [samtec.com/SET](http://samtec.com/SET).

### RUGGED SOLUTIONS

Commercial-off-the-Shelf (COTS), Application-Specific Products (ASP) & Military/Aerospace (MAP) interconnect solutions are available with a variety of rugged features to ensure quality and durability in any application.

### HIGH-SPEED PERFORMANCE

Samtec delivers **Sudden Service**® solutions via a broad line of high-speed, high-density interconnect systems that provide extreme design flexibility, as well as durability and reliability in harsh environments.

# SOSA PICs USING VNX

VITA 74 VNX introduces a new approach to rugged Small Form Factor (SFF) design. A unique module-based format provides system architects greater freedom in developing COTS SFF systems, with a machined chassis, robust backplane and conduction-cooled modules that unite for an extremely rugged assembly.



## VITA 74 VNX SEARAY™ HIGH-DENSITY OPEN-PIN-FIELD ARRAYS

VITA 74 VNX specifies high-density Samtec's SEARAY™ Right-Angle connectors for 19 mm stack heights. SEARAY™ was chosen for its high-speed capabilities and rugged design.

- Ideal for Hardware Plug-in Card Profiles (PICPs) in 19mm VNX cards
- 1.27 mm pitch open-pin-field array with maximum grounding and routing flexibility
- 240, 320 and 400-pin HPC options
- Rugged Edge Rate® contact system
- Lead-free options
- IPC J-STD-001F, IPC-A-610F, meets Class 3 acceptability criteria
- Product roadmap: VITA 90.2 VNX+ Standard extensions for RF and Optical signals
- Visit [samtec.com/VNX](http://samtec.com/VNX) for additional information and specifications

**SEARAY™**

NRZ	PAM4
28 Gbps	56 Gbps

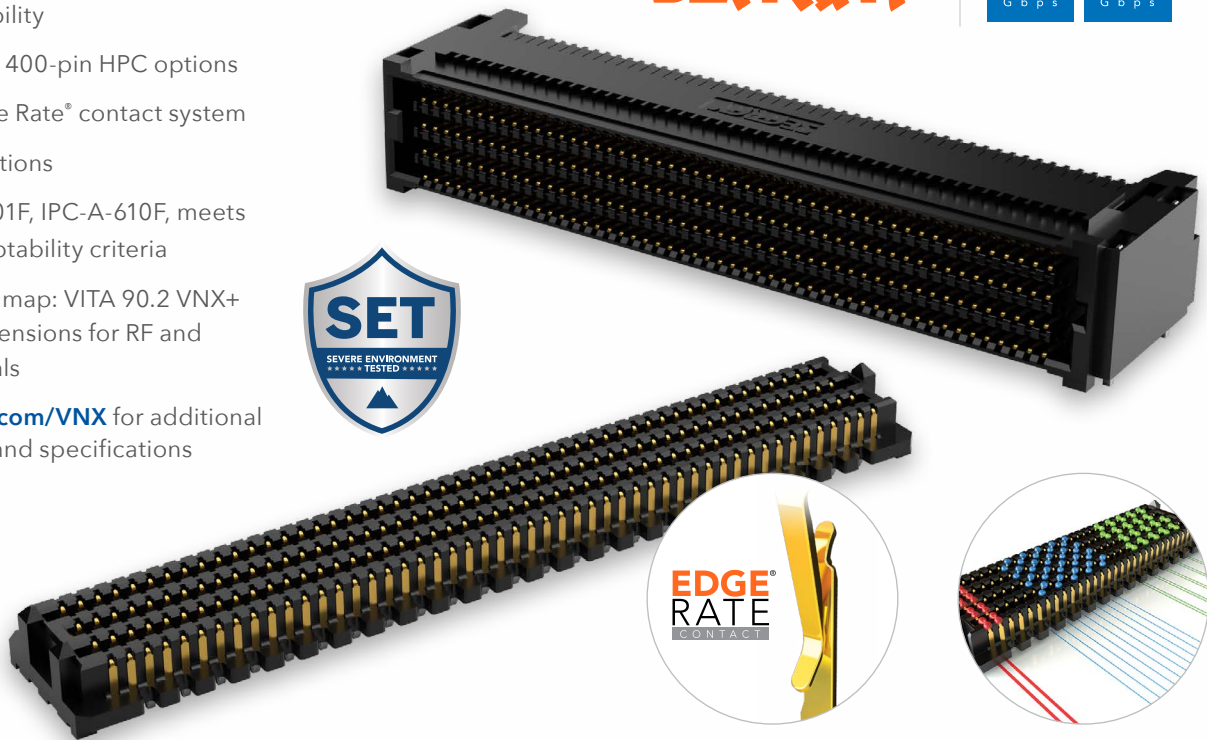

Signal Integrity Optimized Rugged Edge Rate® Contacts

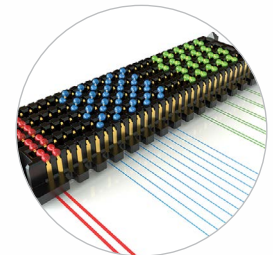

Open-Pin-Field Design for Routing Flexibility

Standard	Samtec Product	Connectors			Options			
		Part No.	12.5 mm Mated (LPC 200 Pin)	19 mm Mated (HPC 400 Pin)	Solder Ball Type	Alignment Pins	Tape & Reel	Plating
VITA 74 VNX™	SEARAY™	ASP-161073-03	Male	–	Lead-Free	✓	✓	10 μ" Gold
		ASP-161074-03	Female	–				
		ASP-161073-04	–	Male				
		ASP-161074-04	–	Female				

## THE EXPANDING VNX ECOSYSTEM

The embedded marketplace continues to drive SWaP (Size, Weight and Power) requirements to the extreme. Many of these demands call for high performance but at a much-reduced size and power.

VITA 74 standard-based products serve markets that require rugged performance, as well as data plane interconnect technologies that closely follow the industry's state-of-the-art.



Various vendors are already incorporating these VNX technologies offering features such as:

- Small Form Factor (SFF) switched serial interconnects
- Open-frame backplane design
- Legacy I/O compatibility at the Plug-In Module level

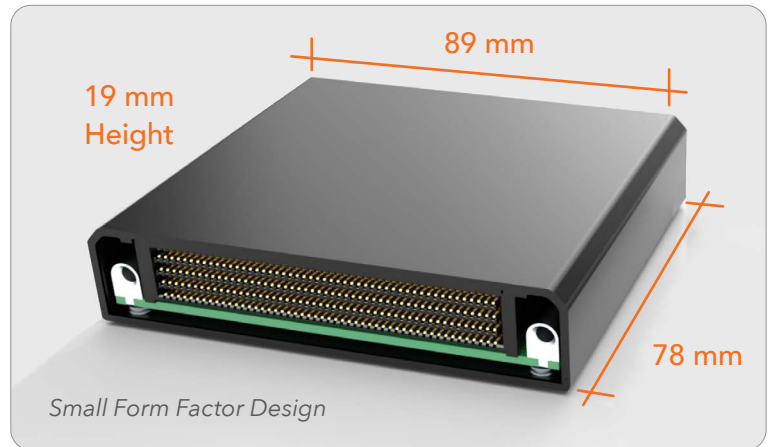

## APPLICATION: TRIDENT INFOSOL RAPTOR VITA 74 VNX COTS COMPUTER

The Raptor is a rugged, small form factor, Commercial Off the Shelf (COTS), pre-qualified computer based on VNX standard. VNX is the continued evolution of the VPX standard specifically designed for significantly smaller deployments.

### Additional Features:

- Small Form Factor Modular Design
- Extended operating temperatures (-40 °C to +71 °C Continuous)
- EMI compliance per MIL-STD-461F
- PCIe® 3.0 compliance

### Featured Samtec Products:

- VITA 74 VNX (12.5 mm Lead-Free) 200-Pin I/O Male Connector (SEARAY™ ASP-161073-01)
- VITA 74 VNX (12.5 mm Lead-Free) 200-Pin I/O Female Connector (SEARAY™ Right-Angle ASP-161074-01)
- VITA 74 VNX (19 mm Lead-Free) 400-Pin I/O Female Connector (SEARAY™ ASP-161073-02)
- VITA 74 VNX (19 mm Lead-Free) 400-Pin I/O Female Connector (SEARAY™ Right-Angle ASP-161074-02)

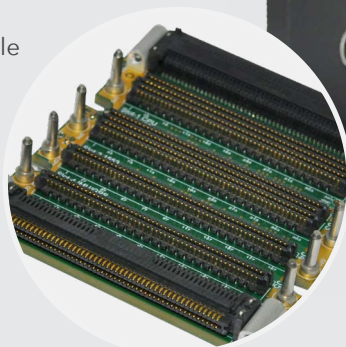

[samtec.com/vnx](http://samtec.com/vnx)

# SOSA PICs USING OpenVPX

VITA 42 XMC is a widely deployed mezzanine standard used in high-reliability computers implementing switched-fabric architectures. VITA 42 XMC provides mezzanine expansion and customization capabilities for SOSA™ PICs using VITA 65 OpenVPX™.



## VITA 42 XMC™ SamArray® HIGH-DENSITY OPEN-PIN-FIELD ARRAYS

VITA 42 XMC specifies solder ball-equipped SamArray® connectors in 10 mm and 12 mm stack heights supporting PCIe® 4.0 performance.

- Ideal for Hardware Plug-in Card Profiles (PICPs) in 6U & 3U VPX form factors
- .050" (1.27 mm) pitch open-pin-field array with maximum grounding and routing flexibility
- 10 mm and 12 mm board stack heights available
- 114-pin (6 x 19) options
- Lead-free and tin-lead options
- Optional pick and place pad and tape and reel packaging



Visit [samtec.com/XMC](http://samtec.com/XMC) for additional information.

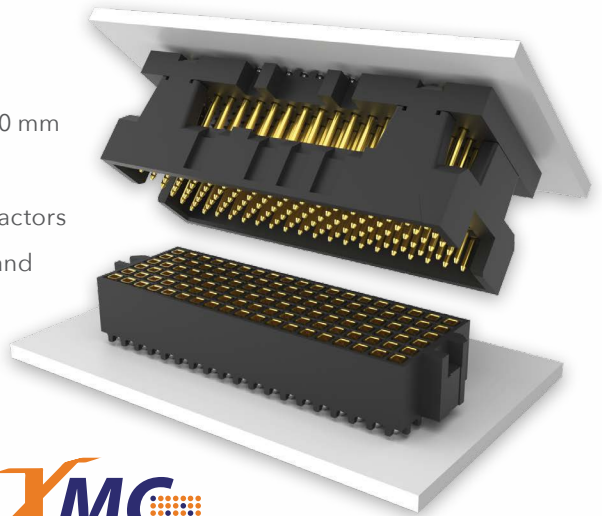

## VITA 88 XMC+ SEARAY™ HIGH-DENSITY OPEN-PIN-FIELD ARRAYS

VITA 88 XMC+ defines an alternative connector backwards compatible with VITA 42 electrical footprints. This allows designers to improve existing VITA 42 and/or VITA 61 designs by swapping connectors. The result is superior Signal Integrity (PCIe® 5.0 and 100 GbE operation) and improved mechanical performance and durability.

- Solder to existing VITA 42/VITA 61 electrical footprints, providing backward compatibility in most applications
- Elevated terminal and standard socket connectors improve channel performance and follow traditional XMC geometry
- Robust housing features protect contacts from stubbing or bent pins
- Rated at 1,000 cycles, the VITA 88 contact system increases mating durability over VITA 42/VITA 61, both rated at 500 cycles
- IPC Class 3 compliant solder charges available in both tin-lead and lead-free RoHS versions
- Available in 10 mm, 12 mm, 16 mm and 18 mm stack heights

Visit [samtec.com/XMC-plus](http://samtec.com/XMC-plus) for additional information.

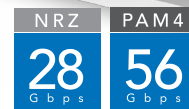
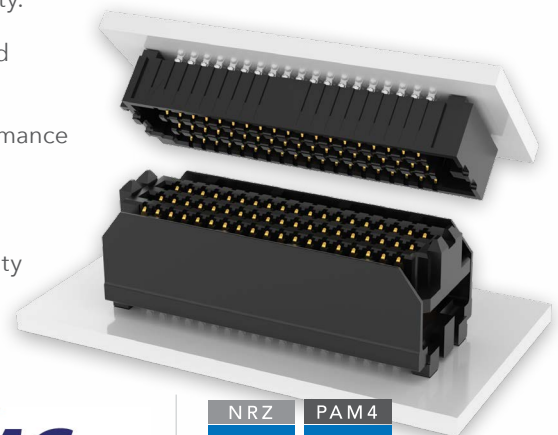



## VITA 42, VITA 57.1/57.4 MICRO JACK SCREW PRECISION BOARD STACKING STANDOFF

Optional standoffs reduce risk of damage when unmating mezzanine cards.

- Designated for PCI/104-Express®, VITA 42, 57.1 and 57.4 systems for use with SamArray® and SEARAY™ connectors
- Divides PCBs in a steady, even motion to reduce risk of component damage
- Works as a traditional standoff
- Available with or without thread locker
- 10 mm and 12 mm board stack heights
- M2.5, M3, and #4-40 threads available
- Operates with a 1.5 mm Allen key or driver
- Visit [samtec.com/xmc](http://samtec.com/xmc) for a full list of JSOM Series configurations

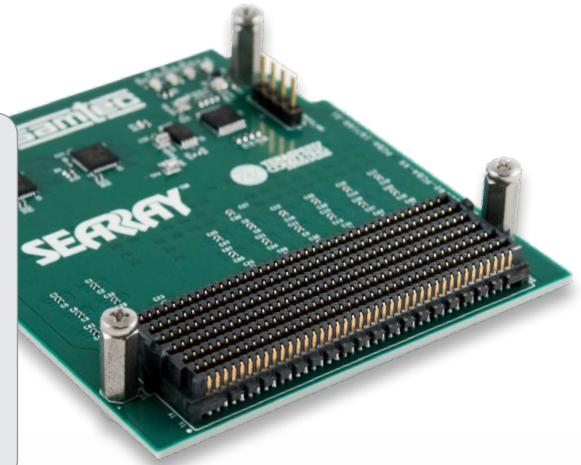

## VITA 57.1 FMC & 57.4 FMC+ CONNECTORS

SEARAY™ Open-Pin-Field Arrays in 10 mm & 12 mm Stack Heights.

- VITA 57.1 FMC: 68 Single-Ended or 34 Differential Pairs (LPC), or 160 Single-Ended or 80 Differential Pairs (HPC)
- VITA 57.4 FMC+ with 560 pins in a 14 x 40 array (HSPC) and an optional extension connector for 80 additional positions in a 4 x 20 array



Visit [samtec.com/VITA](http://samtec.com/VITA) for full details and specifications.

## VITA OPTICS

Extended Temp FireFly™ Optical Micro Flyover System™

- Lane speeds of 10 Gbps and 25 Gbps
- Size, Weight and Power (SWAP) optimized
- Operational temperature range of -40 °C to +85 °C
- Shock and vibration per MIL-STD 810G, relative humidity to 95% non-condensing
- Option for secure firmware
- Multiple connector options including MT38999, MT, MTP®, MXC®, and VITA 66.X



Visit [samtec.com/FireFly](http://samtec.com/FireFly) for full details and specifications.

# GLOBAL MANUFACTURING & SUPPORT



**samtec**  
SUDDEN SERVICE®