

LED MOUNTS/SPACERS

Clips and Rings

- Securely and Uniformly Positions Panel Mounted LEDs
- Molded from Black Nylon per ASTM D-4066 unless noted
- Precision Molded, Improves and Enhances Display Appearance



CR-100 Series Clip and Ring Set

Molded T-1 (3mm) Snap-in Panel Mount
 Color: Black, Price Code: G
 Material: Polypropylene

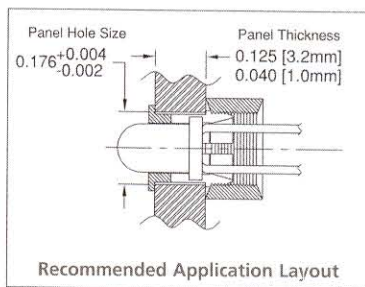
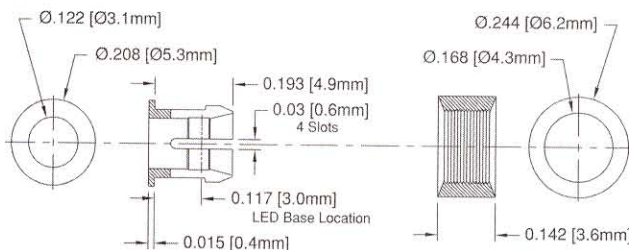

C-103-SR Series

Self-retaining Clip for T-1 (3mm) Flanged LED
 Color: Black, Price Code: G
 Material: Nylon
 Clip made from 94V-0 material

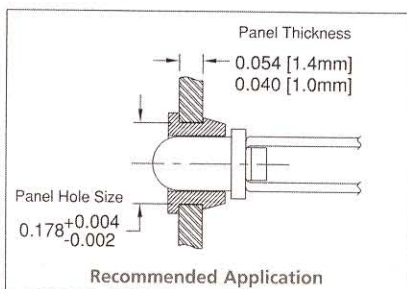
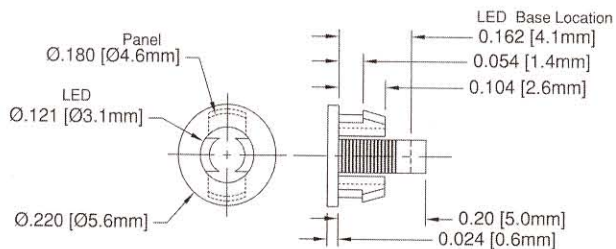

CR-104 Series Clip and Ring Set

Molded T-1 (3mm) Snap-in Panel Mount
 Color: Black, Price Code: G
 Material: Nylon
 Clip made from 94V-0 material

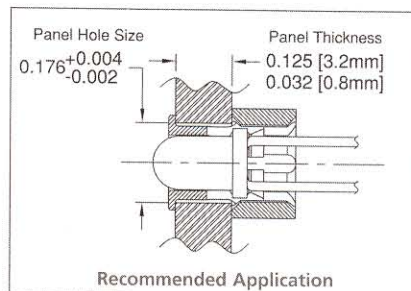
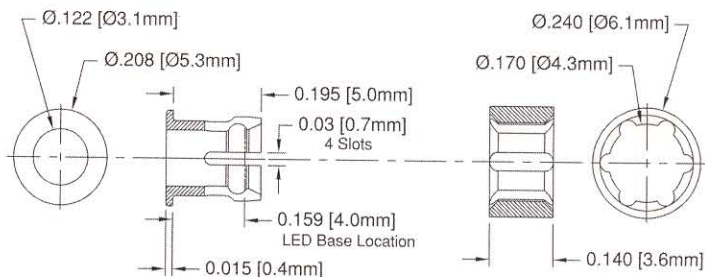

LED MOUNTS/SPACERS

Clips and Rings



C-R25-SR Series

Self-retaining Clip for 2mm x 5mm Rectangular LED with Small Flange

Color: Black, Price Code: G

Material: Nylon

Clip made from 94V-0 material

- Securely and Uniformly Positions Panel Mounted LEDs
- Molded from Black Nylon per ASTM D-4066 unless noted
- Precision Molded, Improves and Enhances Display Appearance

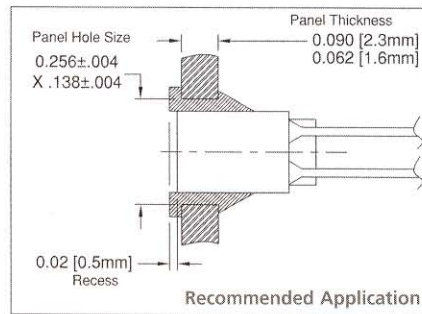
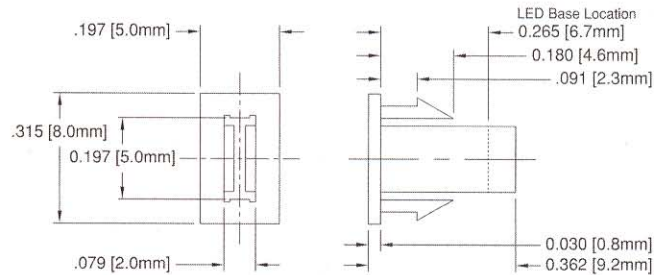

C-105-SR Series

Self-retaining Clip for T-1³/₄ (5mm) Flanged LED

Color: Black, Price Code: G

Material: Nylon

Clip made from 94V-0 material

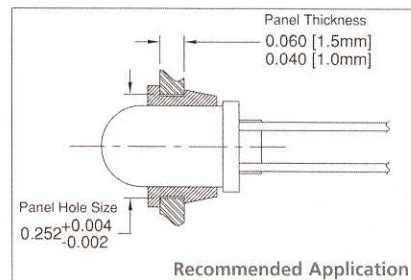
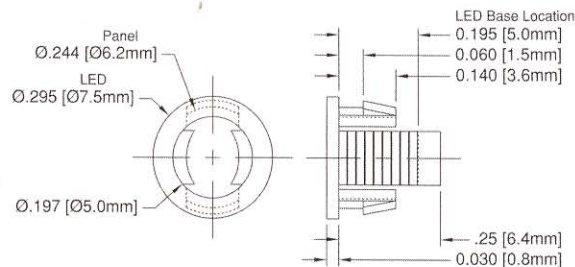

LED MOUNTS/SPACERS

Clips and Rings

- Securely and Uniformly Positions Panel Mounted LEDs
- Molded from Black Nylon per ASTM D-4066 unless noted
- Precision Molded, Improves and Enhances Display Appearance



CR-174 Series Clip and Ring Set

Molded T-1 $\frac{3}{4}$ (5mm) Snap-in Panel Mount
 Color: Black, Price Code: G
 Material: Nylon
 Clip made from 94V-2 material

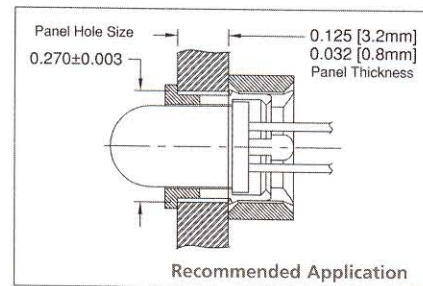
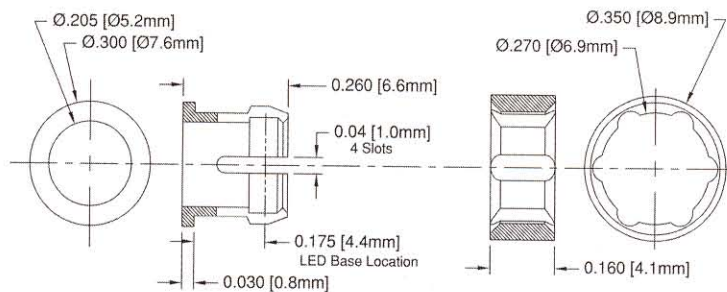

CR-174L Series Clip and Ring Set

Molded T-1 $\frac{3}{4}$ (5mm) Snap-in Panel Mount
 Color: Black, Price Code: I
 Material: Nylon
 Clip made from 94V-2 material

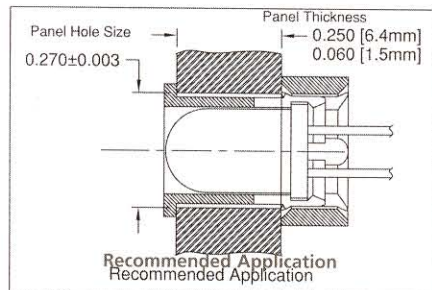
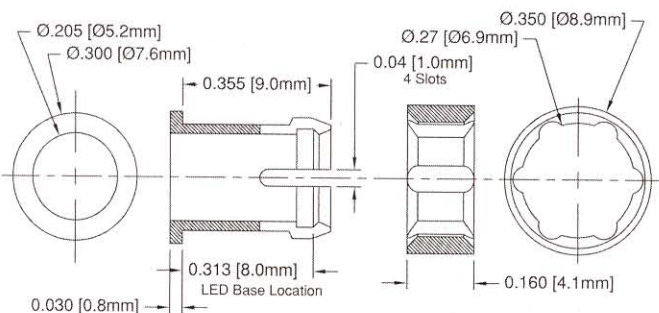

CR-175 Series Clip and Ring Set

Clip and Ring Set for small Flange T-1 $\frac{3}{4}$ (5mm) LEDs
 Color: Black, Price Code: C
 Material: Polypropylene

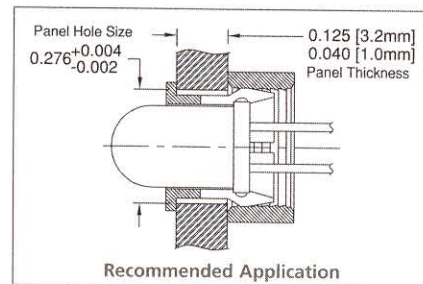
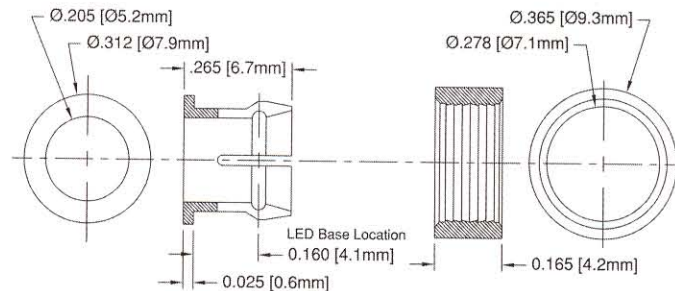

LED MOUNTS/SPACERS

Clips and Rings



- Securely and Uniformly Positions Panel Mounted LEDs
- Molded from Black Nylon per ASTM D-4066 unless noted
- Precision Molded, Improves and Enhances Display Appearance

CR-300 Series

Clip and Ring Set for Bivar Rectangular
RWXD Series LEDs
Color: Black, Price Code: C
Material: Polypropylene

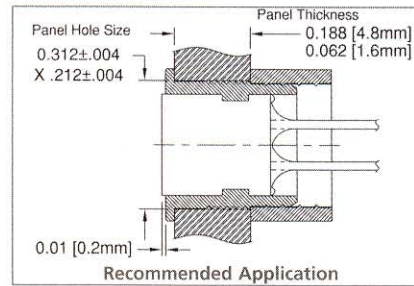
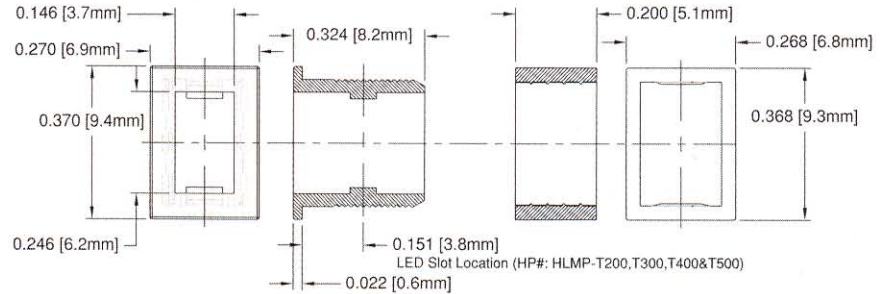

C-301-1 Series

Clip Only, Self-Retaining Panel Mount
for Bivar Rectangular RWXD Series LEDs
Color: Black, Price Code: C
Material: Nylon
Clip made from 94V-0 material

